

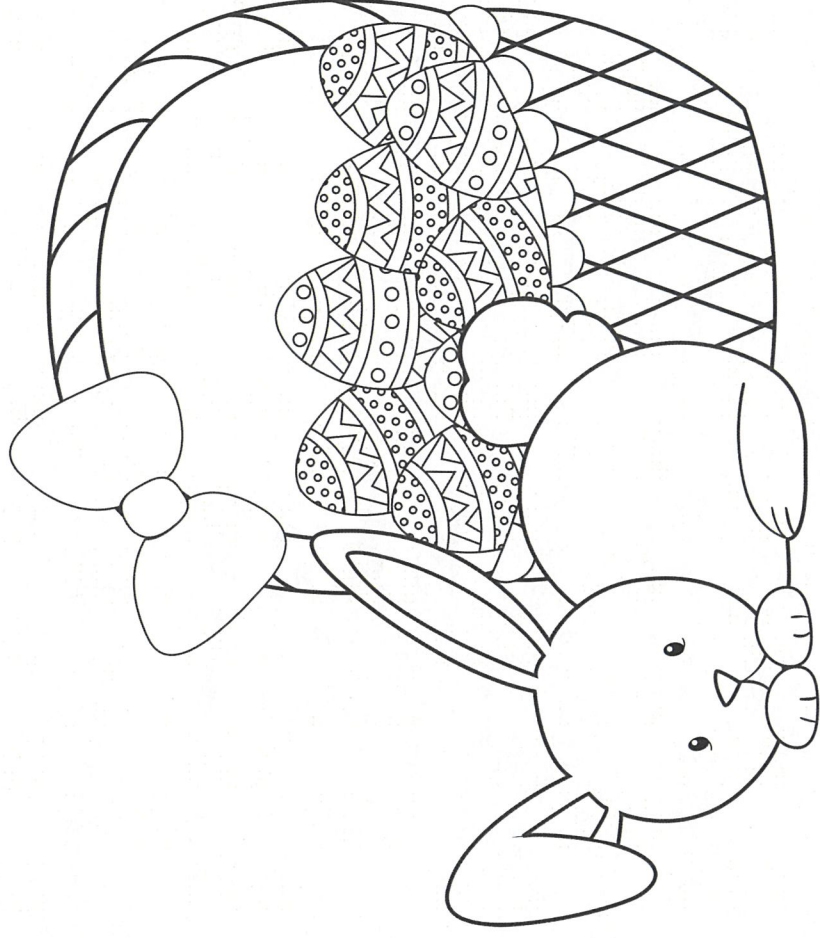

Cambridge Gardens Public School

Weekly Learning Plan - Year One

Unit 3



Name: _____

Teaching and Learning Continuity Plan – Unit 3

Dear Parents and Caregivers,

6th April 2020

We would like to thank you for the wonderful work you are doing at home to support your children at this time. The first units of work are being returned to school via the office and on-line and both students and parents should be very proud of the work that has been completed. We would like to thank students for their hard work and parents who are obviously supporting and assisting their children with remote online learning.

Our continued partnership ensures that we can continue to support our students through online learning and enable our wonderful staff the opportunity to plan appropriately. We have compiled Unit 3 of the Teaching and Learning package, which will continue to be communicated to parents on a weekly basis using our school email system, Google Classroom, Facebook and the School Webpage.

We will continue to make a member of our school staff available for questions and feedback each day for all grades. Please be mindful that the school has only limited phone lines available to use so please be fair and limit your questions to allow all parents access to this provision. Please ask to speak to one of our Assistant Principals.

Stage 1 Unit 3 Information

The Unit 3 booklet includes:

- A Weekly Learning Plan – this is effectively a timetable that outlines daily learning activities that would be completed throughout the course of a week.
- A Learning Environment Checklist that will enable you to set up the best possible environment for your child.
- Following these items will be each day's activities in order. There is space for your child to complete these activities in the booklet only.
- Under most daily activities will be a Success Criteria for your child to complete. This will also be the space for teacher recognition.
- At the end of the booklet, there is a reflection for students and a section for Parents/Caregiver's to sign stating they are happy with the amount of work completed.
- Stage 1 teachers have set two Mathletics learning tasks and one Reading Eggs lesson to be completed daily. Please don't feel restricted to only completing these set tasks if students would like to complete more activities. If you don't have the passwords for your child please respond to the school emails about Mathletics and Reading Eggs passwords.
- Guided reading books are available through the Reading Egg's program in the Library section.
- Google classroom contains the videos mentioned in the teaching and learning framework for students to view to help them with their learning.
- We have added a fast finishers table at the end of the booklet with extra activities for students who would like to engage in additional tasks.

Cambridge Gardens Public School

Innovation, Excellence, Connections & Fun

Weekly Learning Booklets are due on a Monday (except booklet 3 due to SDD)

At this stage we are anticipating that this form of learning may continue into Term 2 and have made the following arrangements for Stage 1 if this does occur.

- Due to the school holidays and the school term beginning on a Tuesday this booklet won't be due until **Tuesday the 28th of April** when school officially begins for students for Term 2. This will also be the time that the following week's booklet will be uploaded on Google Classroom, collected and/or emailed home for Unit 4 only. After this Stage 1 booklets will continue to be due to the front office or via email on a Monday each week.
- **Unit 3 will be due on Tuesday the 28th April, after the Term 1 School Holidays.**
- Please ensure your child's name and class is on the front cover of the booklet.
- Each Stage will have their booklets collected and distributed on different days, as we wish to be as mindful of social distancing.
- If you are returning your work via email, the subject line must be **Mr Wood** only. You must include your child's name and class in the body of the email. This will ensure that your child's work will be forwarded to the right teacher to provide recognition of work. The school's email address is cambridgeg-p.school@det.nsw.edu.au
- For returned student work via email, teacher recognition will be provided back via email on the following Monday.
- For returned student work via the front office, teacher recognition will be provided in a timely manner. This can be collected with the new weekly booklet on the next Monday.

Google Classroom

- Teachers are creating learning activities/videos which will be placed on our Google Classrooms platform. This will link to this unit of work.
- A video has been placed on the school Facebook page and a how to document has been included at the back of each student's Unit 3 booklet.
- Students will need a joining code, which is outlined below. Please only join the grade that your child is in. Any child joining the incorrect classroom will be deleted and need to rejoin the correct class. If you're having difficulty joining your class and cannot access the videos please contact the school for additional options such as dropping off a USB for us to copy the videos on.
- If parents have any questions please contact Mr Wood or Mr Hunter by phone or the school email. If you need your child's student portal login please email the school.

Joining Codes: Year 1 – c3lpj4f

Year 2 – be6r46f

Please be aware that over the coming period, the type, style and delivery of work to students may develop and change. We would like to thank all of our fantastic students and families for their support, patience and kindness during Term 1. May Easter and the holidays be a very special and safe time for you. Stage 1 Teachers,

Mr Wood, Mrs Williams, Mrs Rau, Mrs Smith, Miss Vella, Miss Ryle, Miss Fry and Miss Bates

Cambridge Gardens PS Learning Plan – Stage 1

Unit 3

		Monday	Tuesday	Wednesday	Thursday	School Holidays Begin
Morning	<p><u>English</u></p> <p><u>Spelling</u> Refer to spelling list provided. Write their words and create some sentences.</p> <p><u>Reading</u> Students are to complete one Reading Eggs activity.</p> <p>Write down any tricky words you come across while on Reading Eggs.</p> <p><u>Writing</u> What did you do on the weekend? Try and include who, when, where, why, what.</p>	<p><u>English</u></p> <p><u>Jolly Grammar</u> Complete Jolly Spelling sheet.</p> <p><u>Reading</u> Read a book from the Reading Eggs Library.</p> <p>Complete a retell of the book either verbally or written.</p> <p><u>Writing</u> Describe your favourite toy. What does it look like, feel like, sound like and smell like using adjectives (describing words).</p>	<p><u>English</u></p> <p><u>Jolly Grammar</u> Complete Jolly Grammar sheet.</p> <p><u>Reading/Library</u> Students are to complete one Reading Eggs activity.</p> <p>Optional - Watch Mrs Antonelli's Library video on Google Classroom and make a play with puppets</p> <p><u>Writing</u> Writing – Write a narrative using the picture in the booklet</p>	<p><u>English</u></p> <p><u>Spelling</u> Students complete a spelling test on their spelling words from the week.</p> <p><u>Reading</u> Students are to complete one Reading Eggs activity.</p> <p>Read a book from the Reading Eggs Library.</p> <p>Complete a retell of the book either verbally or written.</p> <p><u>Writing</u> Free Writing – Students can write about anything they like.</p>		
Break						
Middle	<p><u>Number of the day</u> Choose a different number every day and write everything you know about that number. E.g. number before, after, 10 more, 10 less, place value of number and different ways to make the number.</p>	<p><u>Number of the day</u> Choose a different number every day and write everything you know about that number. E.g. number before, after, 10 more, 10 less, place value of number and different ways to make the number.</p>	<p><u>Number of the day</u> Choose a different number every day and write everything you know about that number. E.g. number before, after, 10 more, 10 less, place value of number and different ways to make the number.</p>	<p><u>Number of the day</u> Choose a different number every day and write everything you know about that number. E.g. number before, after, 10 more, 10 less, place value of number and different ways to make the number.</p>		

<p>Optional - Watch Mr Wood teach Number of the Day on Google Classroom</p> <p><u>Mathematics</u> Measurement: Choose an item to use as your measurement tool eg pencil, paddle pop sticks, paperclips or blocks. Use it to measure different objects in your home. Compare the different measurements. Which object was longer? Which object was shorter? Which objects were the same length?</p> <p><u>Mathletics</u> Complete two tasks set for you from your classroom teacher.</p>	<p>Optional - Watch Mr Wood teach Number of the Day on Google Classroom</p> <p><u>Mathematics</u> Roll a die. Record the number. Roll again and add the new number to the previous number. Keep rolling and adding until you reach 20. How many rolls did it take? Choose a different number as the total to reach. Try starting at a number and subtracting the number rolled.</p> <p><u>Mathletics</u> Complete two tasks set for you from your classroom teacher.</p>	<p>Optional - Watch Mr Wood teach Number of the Day on Google Classroom</p> <p><u>Mathematics</u> Statistics and probability: Complete the worksheet provided.</p> <p><u>Mathletics</u> Complete two tasks set for you from your classroom teacher.</p>	<p>Optional - Watch Mr Wood teach Number of the Day on Google Classroom</p> <p><u>Mathematics</u> Play a board game, such as Snakes and Ladders or Trouble, with someone in your house. Try and use your number skills to add and move along the board efficiently.</p> <p><u>Mathletics</u> Complete two tasks set for you from your classroom teacher.</p>	<p>Optional - Watch Mr Wood teach Number of the Day on Google Classroom</p> <p><u>Mathematics</u> Statistics and probability: Complete the worksheet provided.</p> <p><u>Mathletics</u> Complete two tasks set for you from your classroom teacher.</p>
<p>Break</p> <p>Optional - Yoga with Miss Fry – Watch and participate in the Yoga video with Miss Fry on Google Classrooms</p>	<p><u>D.E.A.R</u> Students choose a book to read for enjoyment.</p> <p><u>Science</u> Complete the table. From where you are sitting, record sounds that you can hear and things that you can see.</p>	<p><u>D.E.A.R</u> Students choose a book to read for enjoyment.</p> <p><u>Geography</u> Create a poster announcing a celebratory occasion. Include a large heading, illustration and some examples of what activities/food/ decorations will be at the celebration.</p>	<p><u>D.E.A.R</u> Students choose a book to read for enjoyment.</p> <p><u>Creative Arts</u> Students choose an artwork from Arthub for Kids on YouTube and follow the directed drawing.</p>	<p><u>D.E.A.R</u> Students choose a book to read for enjoyment.</p> <p><u>PE</u> Set up 5 physical activity stations such as skipping, star jumps, bouncing a ball. Rotate around the activities, spending 6 minutes at each.</p> <p>Watch Miss Vella complete this on Google classroom</p>
<p>Afternoon</p>	<p><u>D.E.A.R</u> Students choose a book to read for enjoyment.</p>	<p><u>D.E.A.R</u> Students choose a book to read for enjoyment.</p>	<p><u>D.E.A.R</u> Students choose a book to read for enjoyment.</p>	<p><u>Optional - Smiling Minds with Miss Barbagallo – Watch and participate in the Meditation video with Miss Barbagallo on Google Classrooms</u></p>

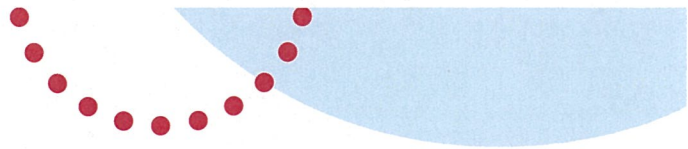

Learning environment checklist

In setting up this space the following should be considered:

- Is the area free of distraction?
- Is there excessive noise in the area?
- Are there trip hazards in the area?
- Is the area exposed to direct glare or reflections?
- Does the area have sufficient power points available?
- Is equipment (extension cords etc.) in good, safe, working condition?
- Is there a proper desk and chair and other necessary equipment (light, stationery and devices)?
- Is the chair adjusted correctly?
 - Feet should be flat on the floor and knees bent at right angles with thighs parallel to the floor.
 - The chair backrest should support the lower back and allow your child to sit upright.
 - The chair should move freely and not be restricted by hazards such as mats and power cords.
 - Chair arm rests should be removed or lowered when typing.
- Is the computer adjusted correctly?
 - The screen should be positioned directly in front of your child.
 - The screen should be at a distance where your child can see clearly and easily without straining. The top of the screen should be slightly lower than eye level.
 - The keyboard should be positioned at a distance where elbows are close to your child's body and their shoulders should be relaxed.
 - The mouse should be placed directly next to the keyboard.
- Are their most frequently used items within easy reach from a seated position?



Spelling Words - 'ss' 'zz'

ox	
run	
from	
buzz	
cross	
less	
miss	
there	
they	
crossroads	

Success Criteria:

I have copied my spelling words correctly.

I have used capital letters and full

stops correctly in my sentences.



Teacher Recognition: _____

Sentences

1.

2.

3.



Writing: Recount

Teacher Recognition:

Success Criteria:

- I have used capital letters at the beginning of my sentences.
- I have used full stops at the end of my sentences.

My Weekend

Firstly, _____

Then, _____

Next, _____

Finally, _____

Write in words

Pick a 2 digit number

—

Now answer all the questions in the boxes 😊

Count up by 10s:

The number before

—

10 more +

—

5 less -

—

Partition (expand) using place value

+



Colour in the correct amount

Find your number and colour it in below

Hundreds Chart

1	2	3	4	5	6	7	8	9	10
11	12	13	14	15	16	17	18	19	20
21	22	23	24	25	26	27	28	29	30
31	32	33	34	35	36	37	38	39	40
41	42	43	44	45	46	47	48	49	50
51	52	53	54	55	56	57	58	59	60
61	62	63	64	65	66	67	68	69	70
71	72	73	74	75	76	77	78	79	80
81	82	83	84	85	86	87	88	89	90
91	92	93	94	95	96	97	98	99	100

Next even number

—

Mathematics:

Choose an item to use as your measurement tool e.g. pencil, paddle pop sticks, paperclips or blocks. Use it to measure different objects in your home. Compare the different measurements. Which object was longer? Which object was shorter? Which objects were the same length?



Longest



Same Length

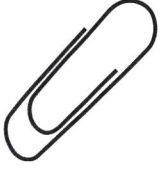

Shortest

Success Criteria:

- I have measured different objects in my home.
- I have compared the different measurements.



Teacher Recognition: _____

Mathletics

Complete two tasks set for you from your classroom teacher.





DEAR: Drop Everything And Read!

Choose a book of your choice to read for enjoyment.



Science

Things That I Can Hear 	Things That I Can See 

Success Criteria:

I have identified things
I can hear.



I have identified things
I can see.



Student: I have completed today's learning plan to the best of my ability. Sign: _____



Parent: I am happy with the amount of work my child has completed in today's learning plan. Sign: _____



Jolly Spelling

Success Criteria:

I have completed my Jolly Spelling worksheet.



Teacher Recognition: _____

Reading Eggs

Read a book from the Reading Eggs Library. Complete a retell of the book either verbally or written.



Writing:

Describe your favourite toy. What does it look like, feel like, sound like and smell like using adjectives (describing words). Draw a picture.

Success Criteria:

I have used a capital letter at the start of every sentence.

I have used a full stop at the end of every sentence.

I have used a variety of adjectives (describing words) in my writing.



Teacher Recognition:

Write an <ss> word in each dress and a <zz> word in the bee.
Draw a picture for each word.

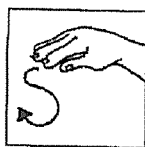

Action: Weave your hand in an 's' shape, like a snake, and say ssssss.



Action: Put your arms out at your sides and flap them like a bee, saying zzzzzzzz.

My Favourite Toy _____

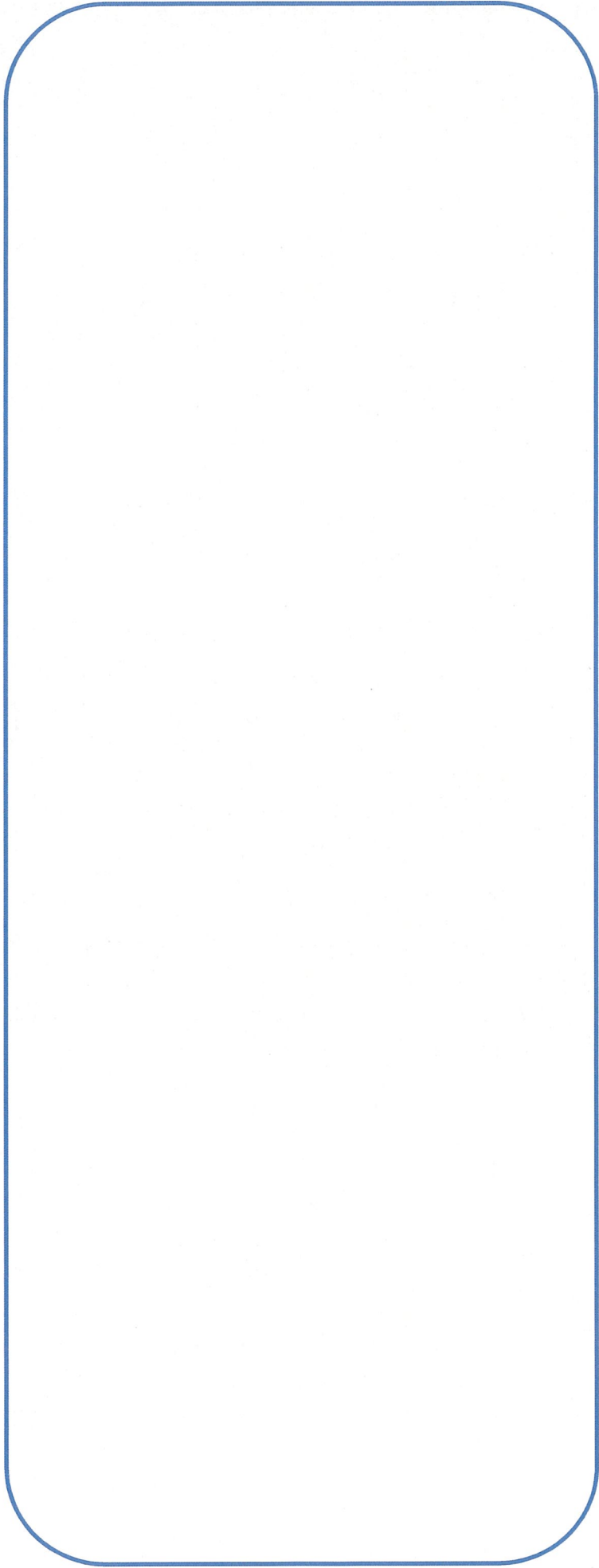

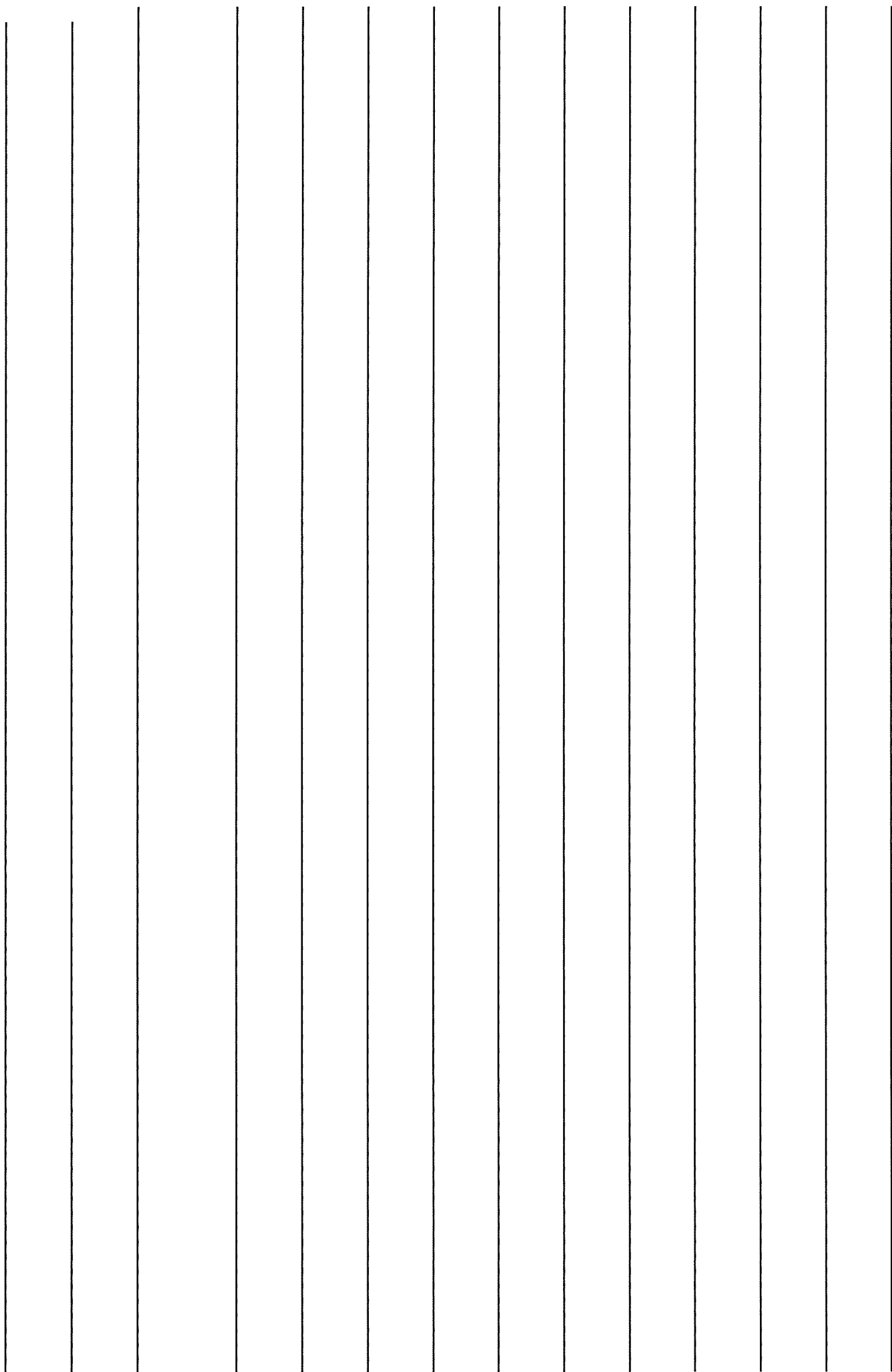

Write in words

Pick a 2 digit number

— —

Now answer all the questions in the boxes 😊

Count up by 10s:

The number before

—

10 more +

—

5 less -

—

Partition (expand) using place value

— + —

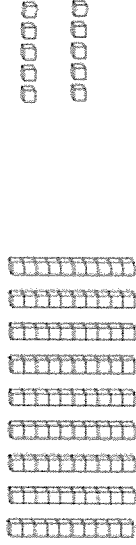

Colour in the correct amount

Next even number

—

Find your number and colour it in below

Hundreds Chart

1	2	3	4	5	6	7	8	9	10
11	12	13	14	15	16	17	18	19	20
21	22	23	24	25	26	27	28	29	30
31	32	33	34	35	36	37	38	39	40
41	42	43	44	45	46	47	48	49	50
51	52	53	54	55	56	57	58	59	60
61	62	63	64	65	66	67	68	69	70
71	72	73	74	75	76	77	78	79	80
81	82	83	84	85	86	87	88	89	90
91	92	93	94	95	96	97	98	99	100

Mathematics: Dice game

Equipment:

- Dice

How to play:

1. Roll the dice and record the number.
2. Roll again and add the new number to the previous number.
3. Keep rolling and adding until you reach 20. How many rolls did it take?
4. Choose a different number as the total to reach e.g. 30 or try starting at a number and subtracting the number rolled.



Success Criteria:

I played this game with _____



many times.

I have added numbers to 20.



Record your results here:

Mathletics

Complete two tasks set for you from your classroom teacher.

DEAR: Drop Everything And Read!

Choose a book of your choice to read for enjoyment.

Art

Choose an artwork from Art for Kids Hub on YouTube and create your drawing below.

Here is an example: YouTube - How To Draw An Easter Chick- Art For Kids Hubs.

<https://www.youtube.com/watch?v=8V5eBOz19O4>

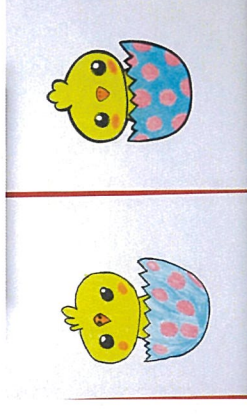

Success Criteria:

I have drawn and coloured my directed drawing.



Teacher Recognition: _____

Student: I have completed today's learning plan to the best of my ability. Sign: _____

Parent: I am happy with the amount of work my child has completed in today's learning plan. Sign: _____



Jolly Grammar

Success Criteria:

I have completed my Jolly Grammar worksheet.



Teacher Recognition: _____

Reading Eggs: Complete one Reading Eggs activity. Here are some tricky words I found while on Reading Eggs: _____



Watch Mrs Antonelli's Library video on Google Classroom and make a play with puppets



Writing: Write a narrative using the picture in the booklet.

Teacher Recognition:

Success Criteria:

I have used a capital letter at the start of every sentence.



I have used a full stop at the end of every sentence.



I have included a beginning, middle and end to my narrative.



I have included a variety of adjectives (describing words) in my writing.



Pronouns Pink

Colour the pronouns pink. Draw a picture for each pronoun.
Remember which are singular and which are plural.

I  Pink

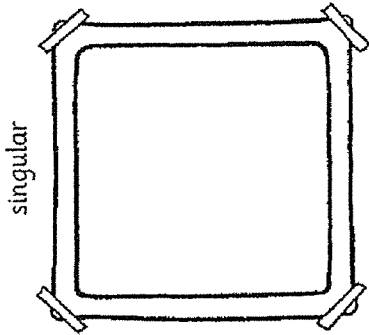

you

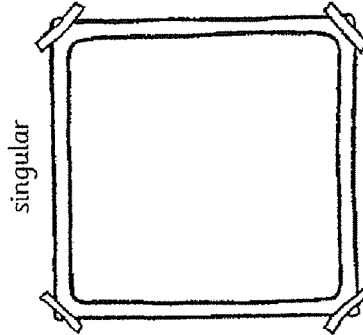

he

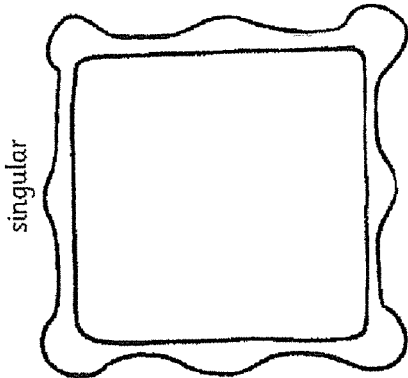

she

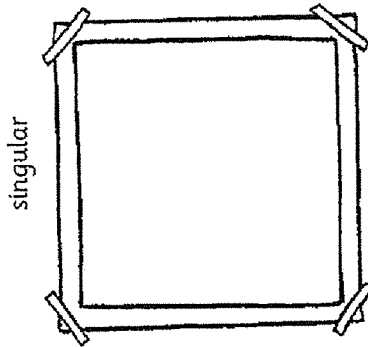

it

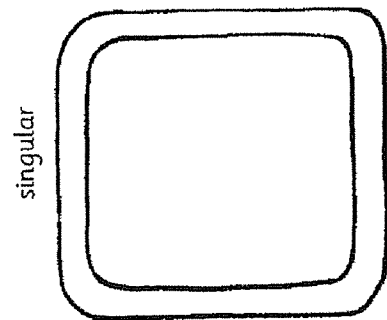

we

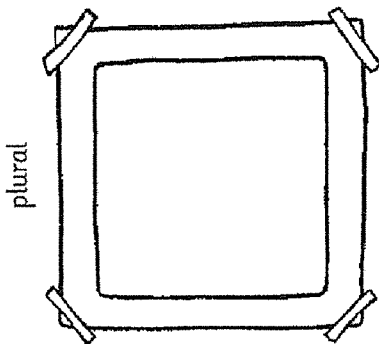

you

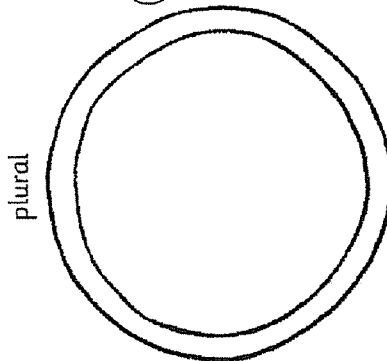

they

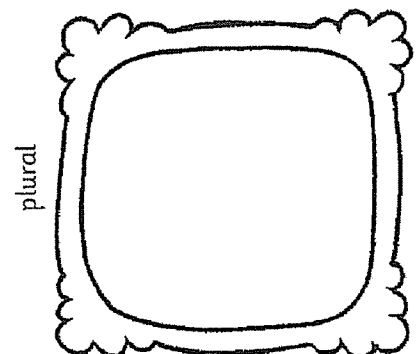

Title: _____



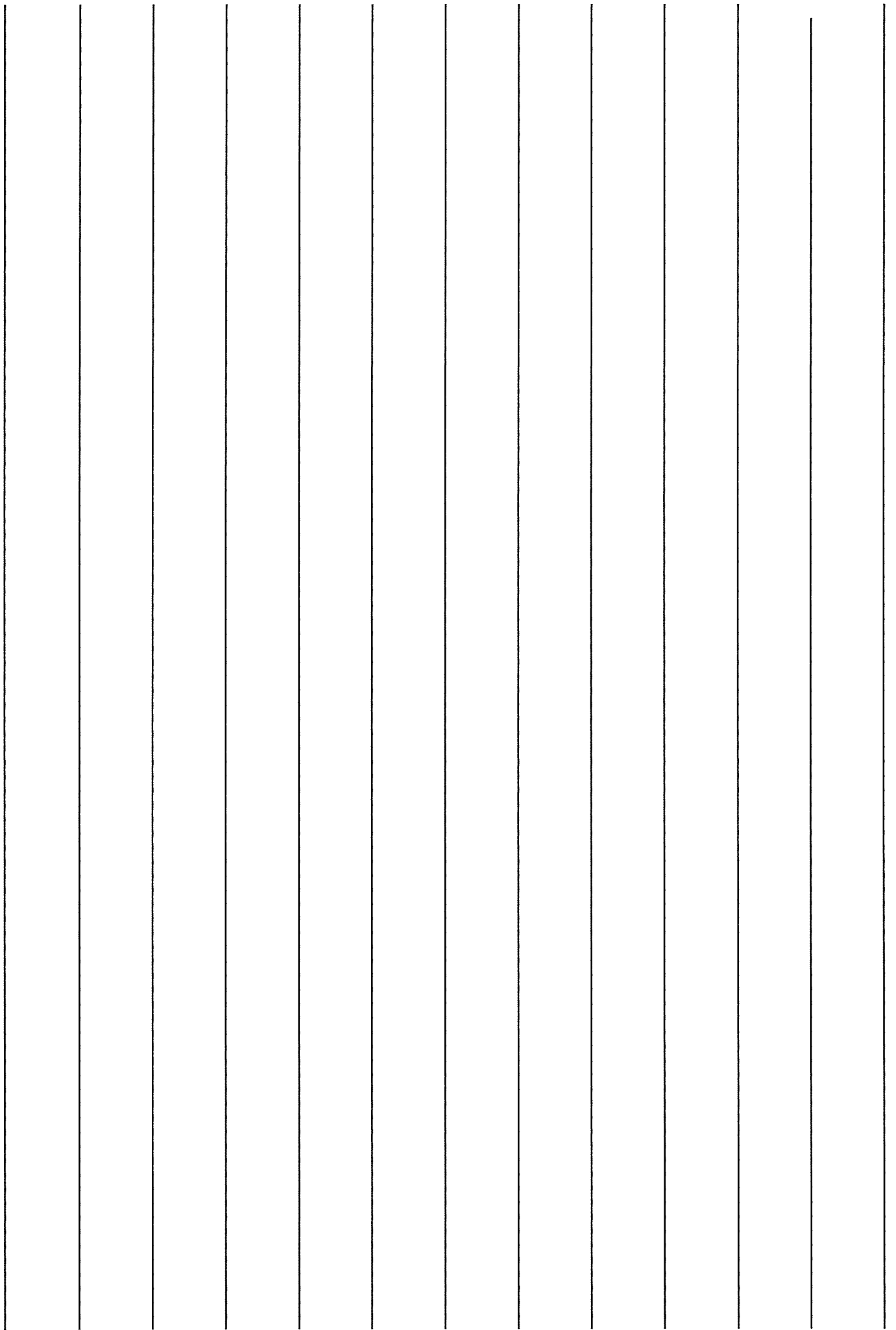

Write in words

Pick a 2 digit number

Now answer all the questions in the boxes 😊

Count up by 10s:

The number before

10 more +

5 less -

Partition (expand) using place value

+

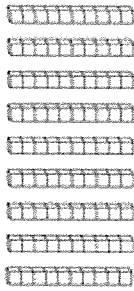

Colour in the correct amount

Find your number and colour it in below

Hundreds Chart

1	2	3	4	5	6	7	8	9	10
11	12	13	14	15	16	17	18	19	20
21	22	23	24	25	26	27	28	29	30
31	32	33	34	35	36	37	38	39	40
41	42	43	44	45	46	47	48	49	50
51	52	53	54	55	56	57	58	59	60
61	62	63	64	65	66	67	68	69	70
71	72	73	74	75	76	77	78	79	80
81	82	83	84	85	86	87	88	89	90
91	92	93	94	95	96	97	98	99	100

Next even number

Graph Information

Data 2.1

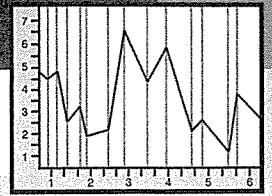

Name _____

Date _____

These vehicles were seen passing the school.

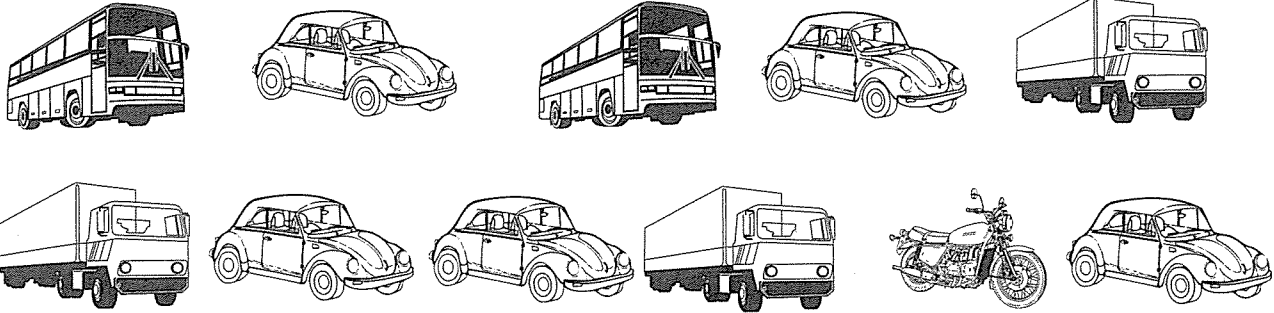

1 Use tally marks as you count.

- a How many cars were seen? _____
- b How many buses were seen? _____
- c How many trucks were seen? _____
- d How many motor bikes were seen? _____

2 Colour a square for each vehicle.

Traffic Survey

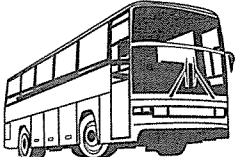
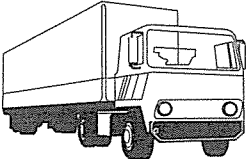
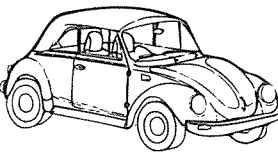
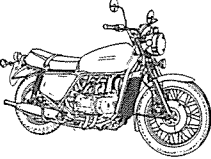
	<input type="checkbox"/>	<input type="checkbox"/>	<input type="checkbox"/>	<input type="checkbox"/>	<input type="checkbox"/>
	<input type="checkbox"/>	<input type="checkbox"/>	<input type="checkbox"/>	<input type="checkbox"/>	<input type="checkbox"/>
	<input type="checkbox"/>	<input type="checkbox"/>	<input type="checkbox"/>	<input type="checkbox"/>	<input type="checkbox"/>
	<input type="checkbox"/>	<input type="checkbox"/>	<input type="checkbox"/>	<input type="checkbox"/>	<input type="checkbox"/>

Data representation and interpretation: ACMSP049 Collect, check and classify data. Fluency: Use tally marks to count items. Record data on a graph to display information.

Mathematics

Complete the Graph Information worksheet provided.

Mathletics

Complete two tasks set for you from your classroom teacher.

Mathletics

DEAR: Drop Everything And Read!

Choose a book of your choice to read for enjoyment.



Geography

Using the following page, create a poster announcing a celebratory occasion e.g. birthday party, Easter. Include a large heading, illustration and some examples of what activities/food/ decorations will be at the celebration.

Success Criteria:

I have created a poster about a celebration.

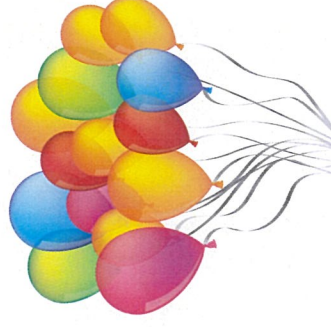

Teacher Recognition: _____

Student: I have completed today's learning plan to the best of my ability. Sign: _____



Parent: I am happy with the amount of work my child has completed in today's learning plan. Sign: _____



My Celebration Poster:



Spelling Test

Score: ___ / 10

Success Criteria:

I have completed my spelling test.



Teacher Recognition: _____

Free Writing

Use the pages below to write about anything they like.
Here is a link you can use for ideas:

<http://www.scholastic.com/teachers/story-starters/>



Success Criteria:

I have used a capital letter at the start of every sentence.



I have used a full stop at the end of every sentence.



Teacher Recognition:

Reading Eggs: Please complete one Reading Eggs activity. Read a book from the Reading Eggs Library and complete a retell either verbally or written.

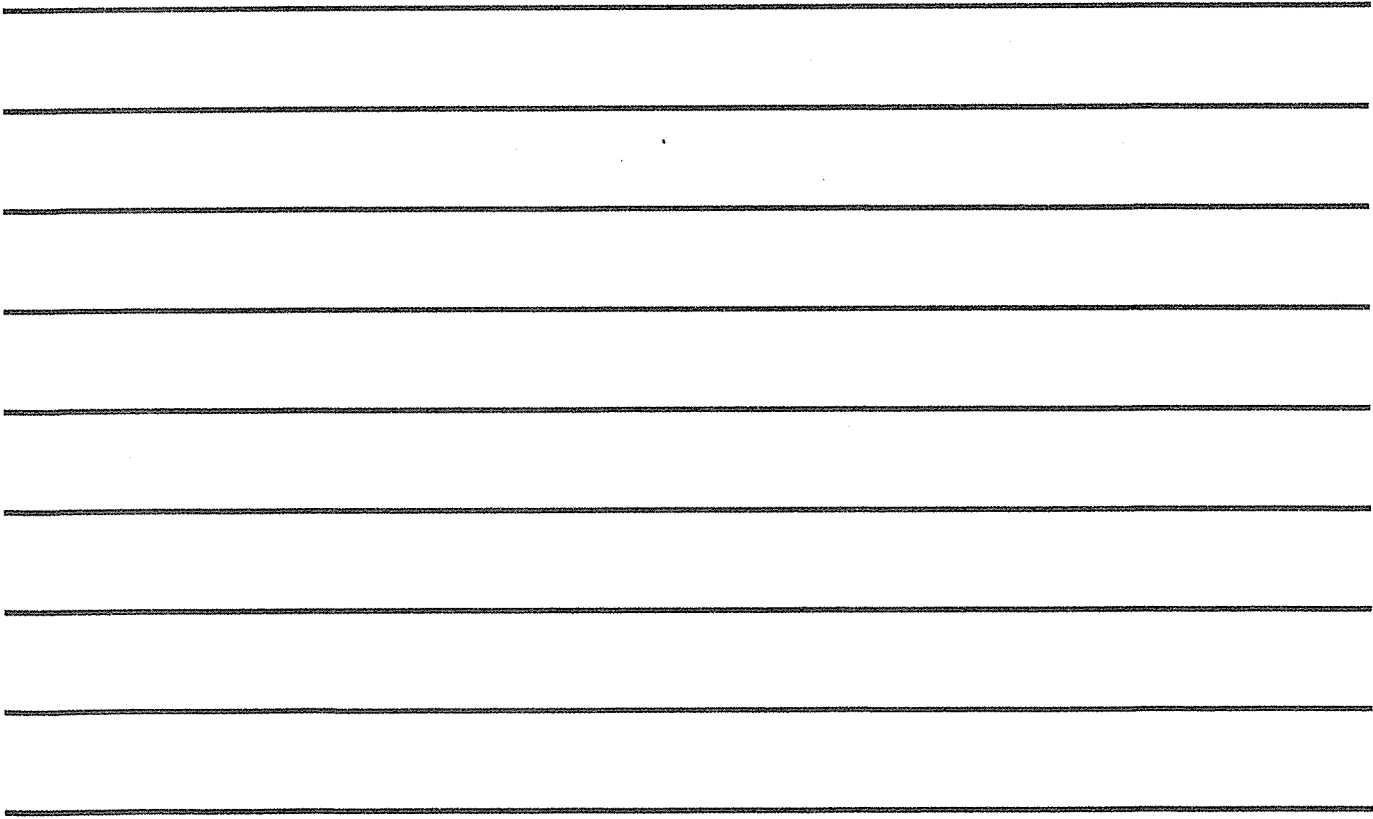
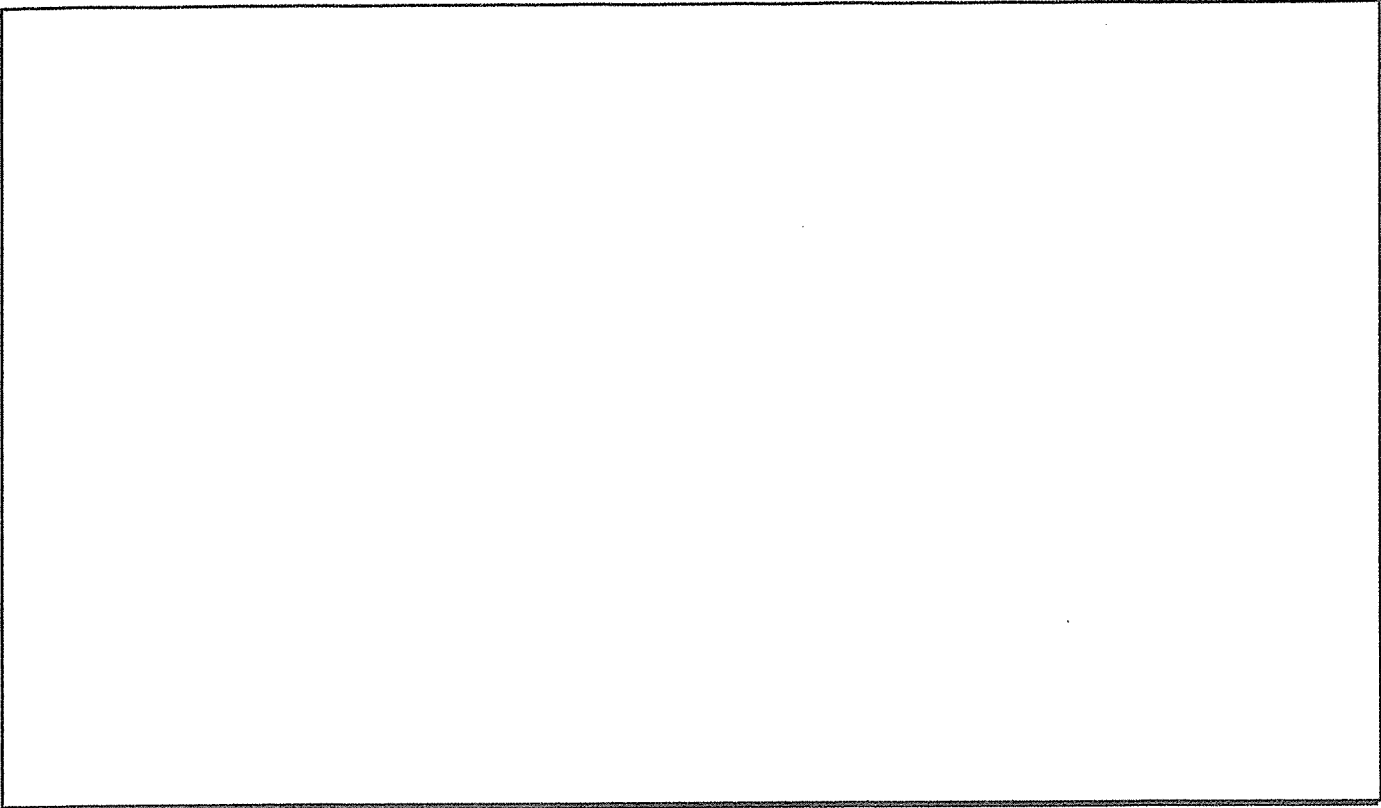

Write in words

Pick a 2 digit number

Now answer all the questions in the boxes 😊

Count up by 10s:

The number before

10 more +

5 less -

Partition (expand) using place value

___ + ___

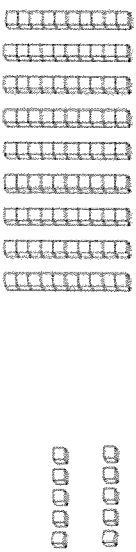

Colour in the correct amount

Next even number

Find your number and colour it in below

Hundreds Chart

1	2	3	4	5	6	7	8	9	10
11	12	13	14	15	16	17	18	19	20
21	22	23	24	25	26	27	28	29	30
31	32	33	34	35	36	37	38	39	40
41	42	43	44	45	46	47	48	49	50
51	52	53	54	55	56	57	58	59	60
61	62	63	64	65	66	67	68	69	70
71	72	73	74	75	76	77	78	79	80
81	82	83	84	85	86	87	88	89	90
91	92	93	94	95	96	97	98	99	100

Mathematics

Play a board game, such as Snakes and Ladders or Trouble, with someone in your house. Try and use your number skills to add and move along the board efficiently. You can use the Snakes and Ladders board below if you like.

Success Criteria:

I have played a board game with _____.



Teacher Recognition: _____

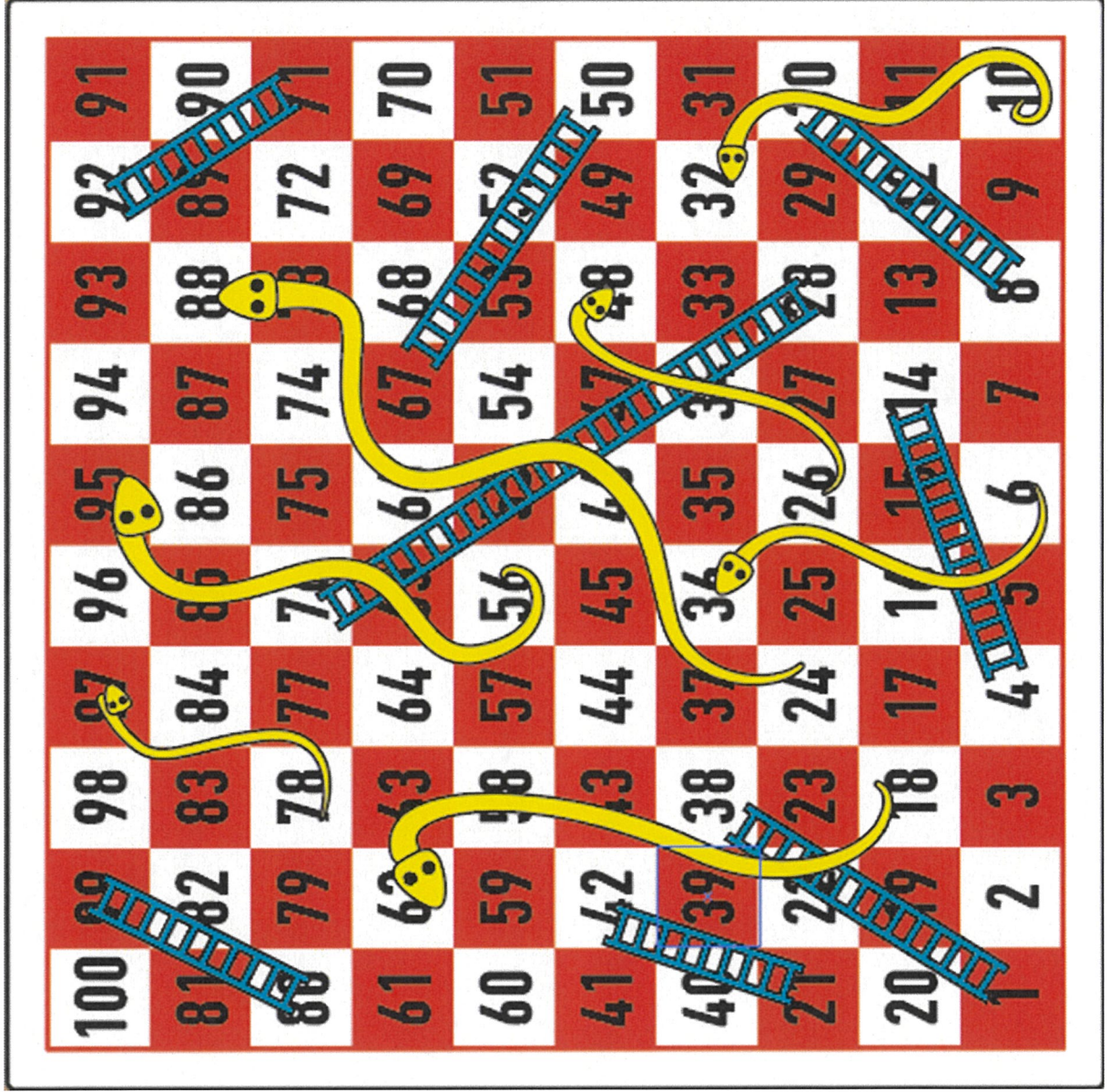

Mathletics

Complete two tasks set for you from your classroom teacher.

Mathletics

DEAR: Drop Everything And Read!

Choose a book of your choice to read for enjoyment.



PDHPE

Set up 5 physical activity stations such as skipping, star jumps or bouncing a ball. Rotate around the activities, spending 6 minutes at each.

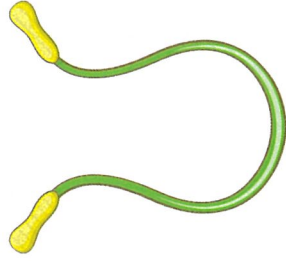

Success Criteria:

I have spent at least 30 minutes doing physical activity.

Teacher Recognition: _____

Student: I have completed today's learning plan to the best of my ability. Sign: _____



Parent: I am happy with the amount of work my child has completed in today's learning plan. Sign: _____





Cambridge Gardens Public School
Year 1 Fast Finishers Grid
Unit 3



Write my spelling list in alphabetical order.	Create a find-a-word using my spelling list.	Make friends of ten using a set of cards.	Name as many objects around your home beginning with 'e'.	Read a story to a family member.
Share a group of objects equally amongst your family members.	Search 'Fit Futures Australia' on YouTube. Choose an activity and join in.	Do something to help a family member.	Play charades using any verbs you can think of.	Tell a family member about something interesting you learnt today.
List as many objects around your home that are cylinders.	Write as many words as you can beginning with the sound 'th'.	Write a list of words that rhyme with 'boat'.	Draw a picture of an animal and write some adjectives about it.	YouTube a GoNoodle activity and join in.
Create a map of your house.	Help a family member clean the kitchen.	Show a family member how to wash your hands correctly.	Create your own dance to a piece of music and show a family member.	List five ways we can stay safe when we are outside.

How to access Google Classrooms instructions

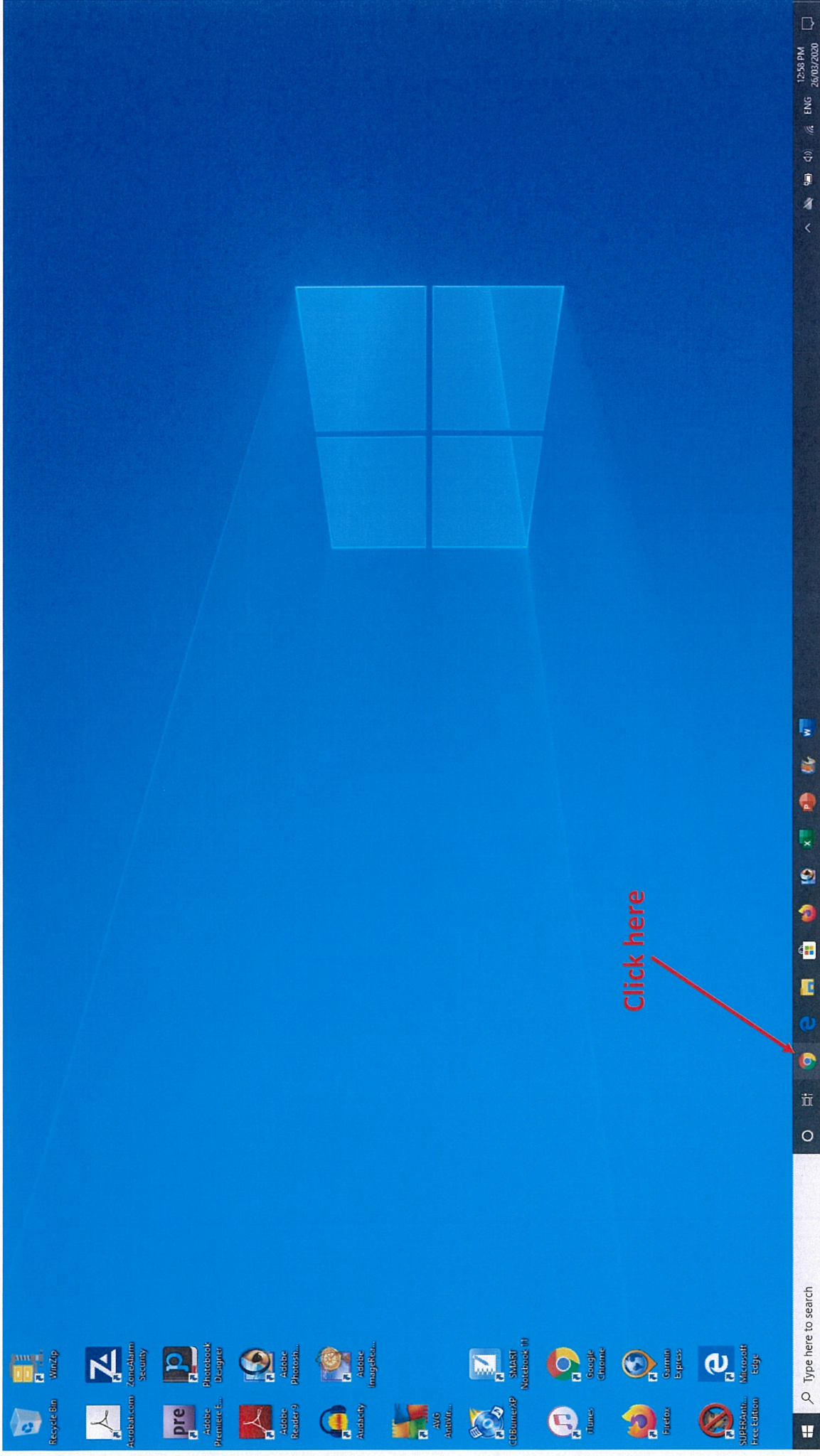

1. Click on your internet browser icon to open your internet browser.

How to access Google Classrooms instructions

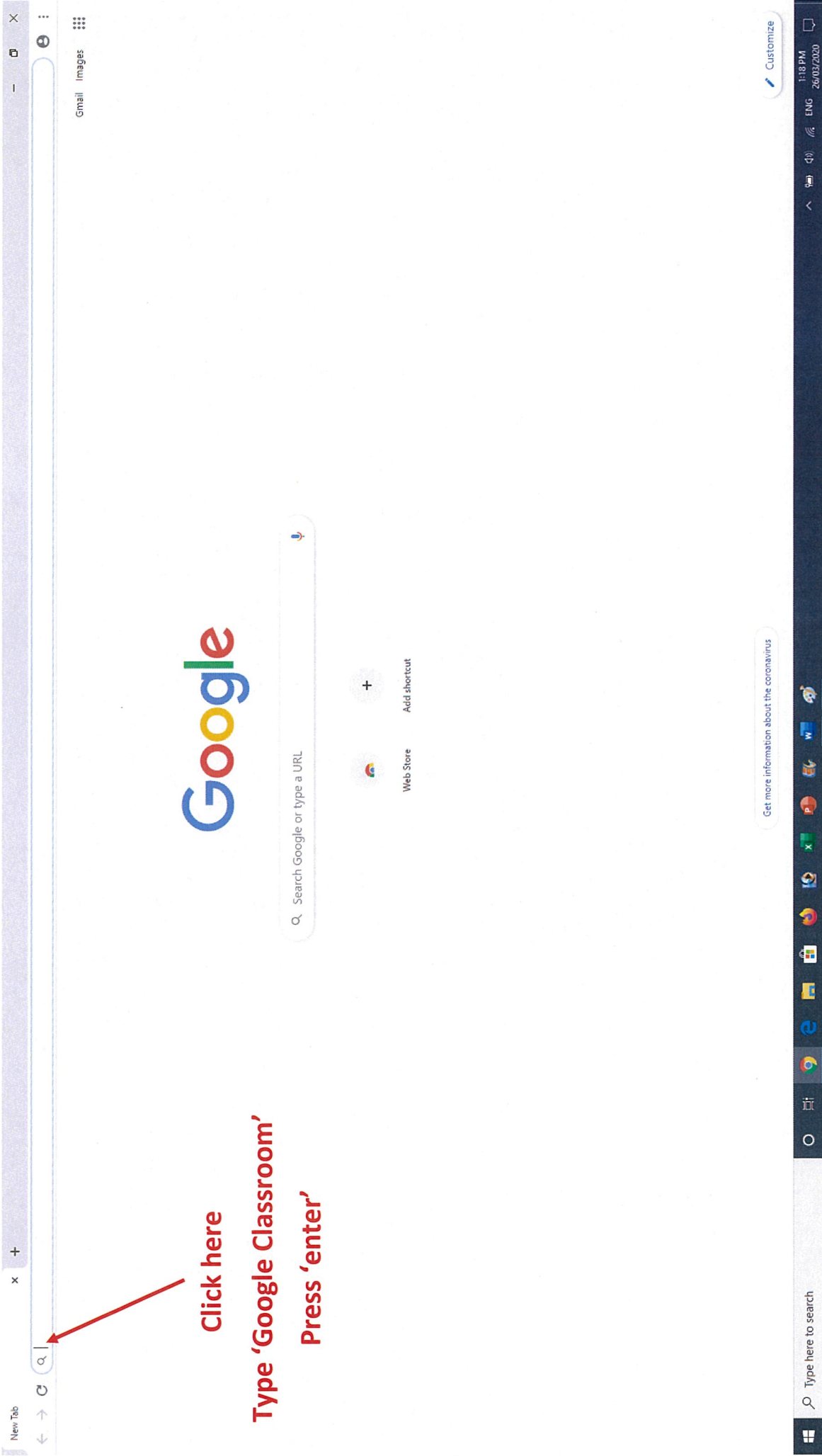

Click here

**Type 'Google Classroom'
Press 'enter'**

2. Click in the URL/search bar and type Google Classroom. Press enter.

How to access Google Classrooms instructions

The screenshot shows a Google search for "google classroom". The search results include a link to "classroom.google.com" with a red arrow pointing to it and the text "Click here". Below the search results, there is a "Videos" section with several video thumbnails, including "GOOGLE CLASSROOM TUTORIAL" and "The NEW Google Classroom - Full Tutorial".

The main content area displays the Google Classroom product page. It features the Classroom logo, a description of the service, and a "Sign in" button. The description states: "Google Classroom is a free web service, developed by Google for schools, that aims to simplify creating, distributing, and grading assignments in a paperless way. The primary purpose of Google Classroom is to streamline the process of sharing files between teachers and students. Wikipedia".

Additional information on the page includes:

- Developed by:** Google
- Initial release date:** 12 August 2014
- Operating system:** iOS; Android; web browser

Below this information, there is a section titled "People also search for" which lists related services: Google Docs, Google Slides, Google Drive, Gmail, and Google Sheets. A "Feedback" link is also present.

3. Click the 'Google Classroom' link

How to access Google Classrooms instructions

The screenshot shows the Google Classroom website interface. At the top, there is a navigation bar with the following links: "Why Google", "Products", "Teaching Resources", "Code with Google", "Training & Support", "The Latest", "Get products", and "Contact us". Below this, the main heading reads "Manage teaching and learning with Classroom". Underneath the heading, a sub-heading states: "Classroom helps students and teachers organize assignments, boost collaboration, and foster better communication." A blue button labeled "Go to Classroom" is prominently displayed. A red arrow points from the text "Click here" to this button. Below the button, there is a link: "Having trouble signing into Classroom? [Get tips and help here.](#)" At the bottom of the page, there is a large video player showing a woman with glasses and a man with a headset. The Windows taskbar is visible at the bottom of the screen, showing the search bar, task view icon, and several application icons. The system tray shows the time as 1:28 PM and the date as 26/03/2020.

4. Click the 'Go to Classroom' icon

How to access Google Classrooms instructions

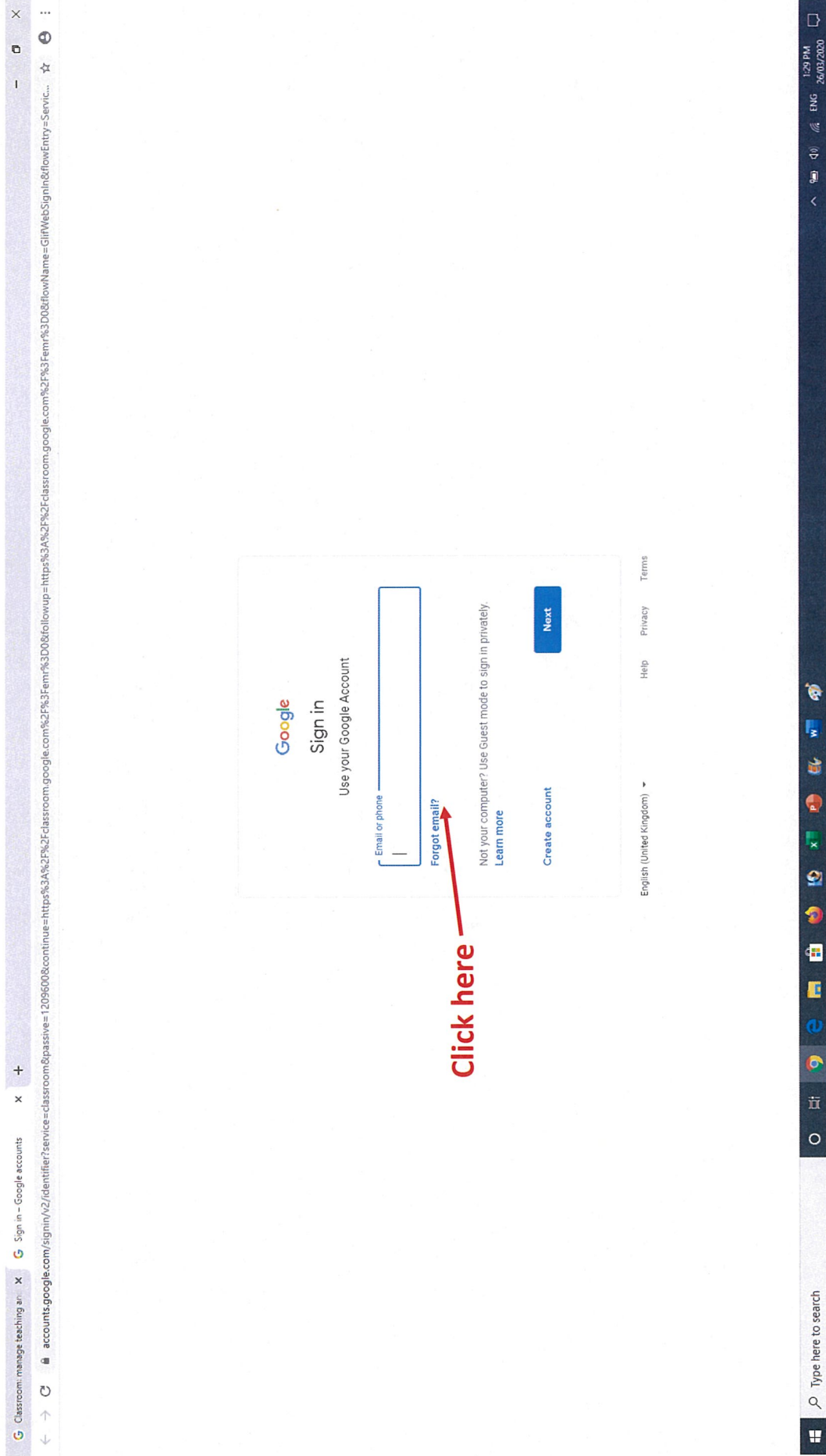

5. Click in the “Email or phone” bar and type in your student login, followed by “@education.nsw.gov.au”

For example: **Alexander.Nelson8@education.nsw.gov.au**

How to access Google Classrooms instructions

The screenshot shows a web browser window displaying the Google Sign in page. The browser's address bar contains a long URL starting with 'accounts.google.com'. The page content includes the Google logo, the text 'Sign in Use your Google Account', and a text input field containing the email address 'alexander.nelson8@education.nsw.gov.au'. Below the input field are links for 'Forgot email?', 'Not your computer? Use Guest mode to sign in privately', and 'Learn more'. A blue 'Next' button is positioned to the right of the input field. A red arrow points from the text 'Click here' to the 'Next' button. At the bottom of the page, there are links for 'English (United States)', 'Help', 'Privacy', and 'Terms'. The Windows taskbar is visible at the bottom of the screen, showing the search bar and various application icons.

6. Click 'Next'

How to access Google Classrooms instructions

NSW DEPARTMENT OF EDUCATION

Login with your DoE account

User ID

Enter your user ID
Example: jane.citizen

Password

Enter your password

Log in

[Forgot your password?](#)

Have trouble logging in?
[Help for DoE staff](#)

NSW GOVERNMENT | Education

ACCESSIBILITY
INFORMATION ACCESS
PRIVACY

COPYRIGHT
DEPARTMENT CONTACTS
NSW GOVERNMENT

1:44 PM 26/03/2020

7. Type in your User ID and your password. Click the 'Log In' icon.

(Your user ID and password are the same that you use to login to the computers at school.)

How to access Google Classrooms instructions

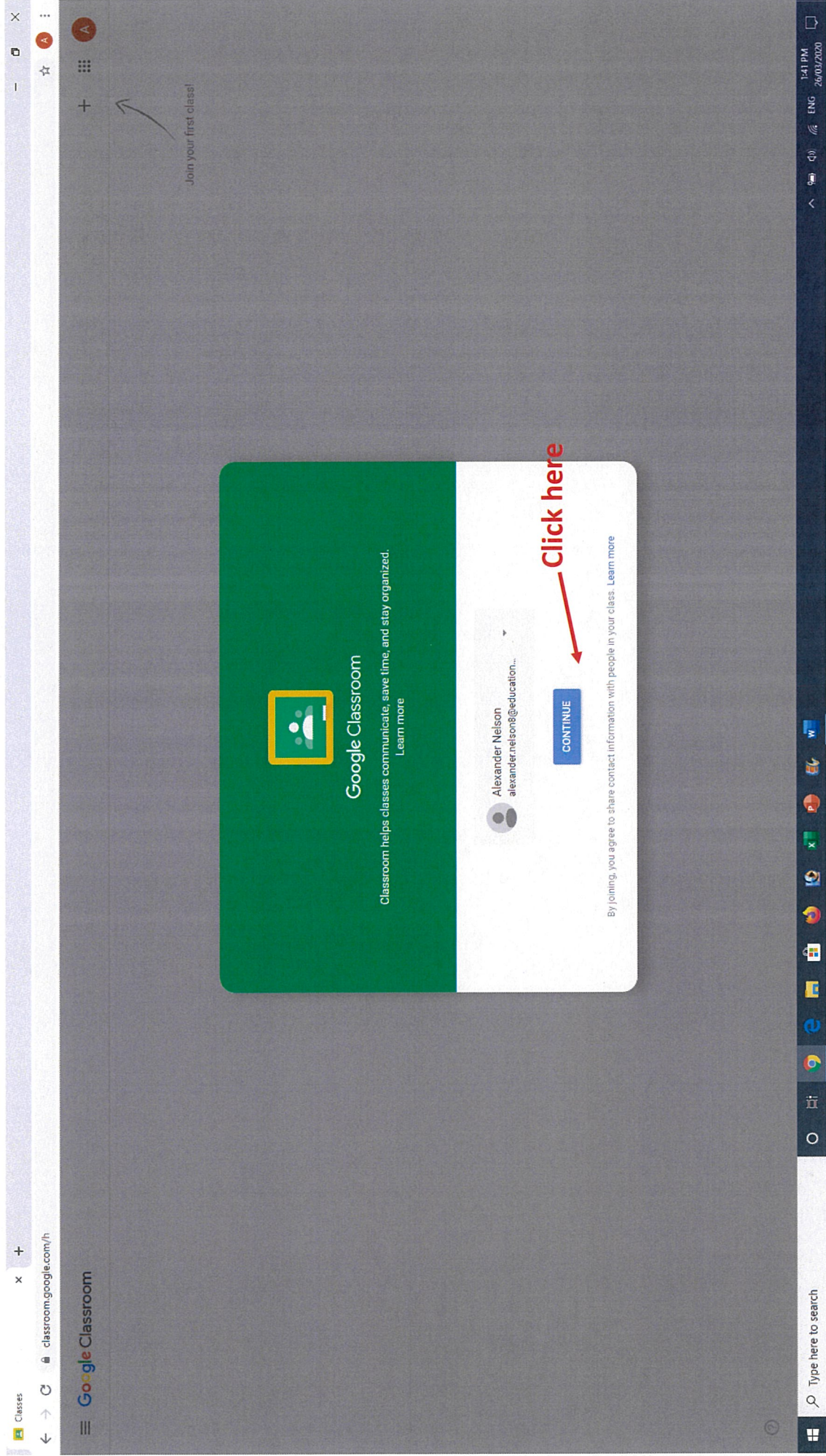

9. Click the 'Continue' icon.

How to access Google Classrooms instructions

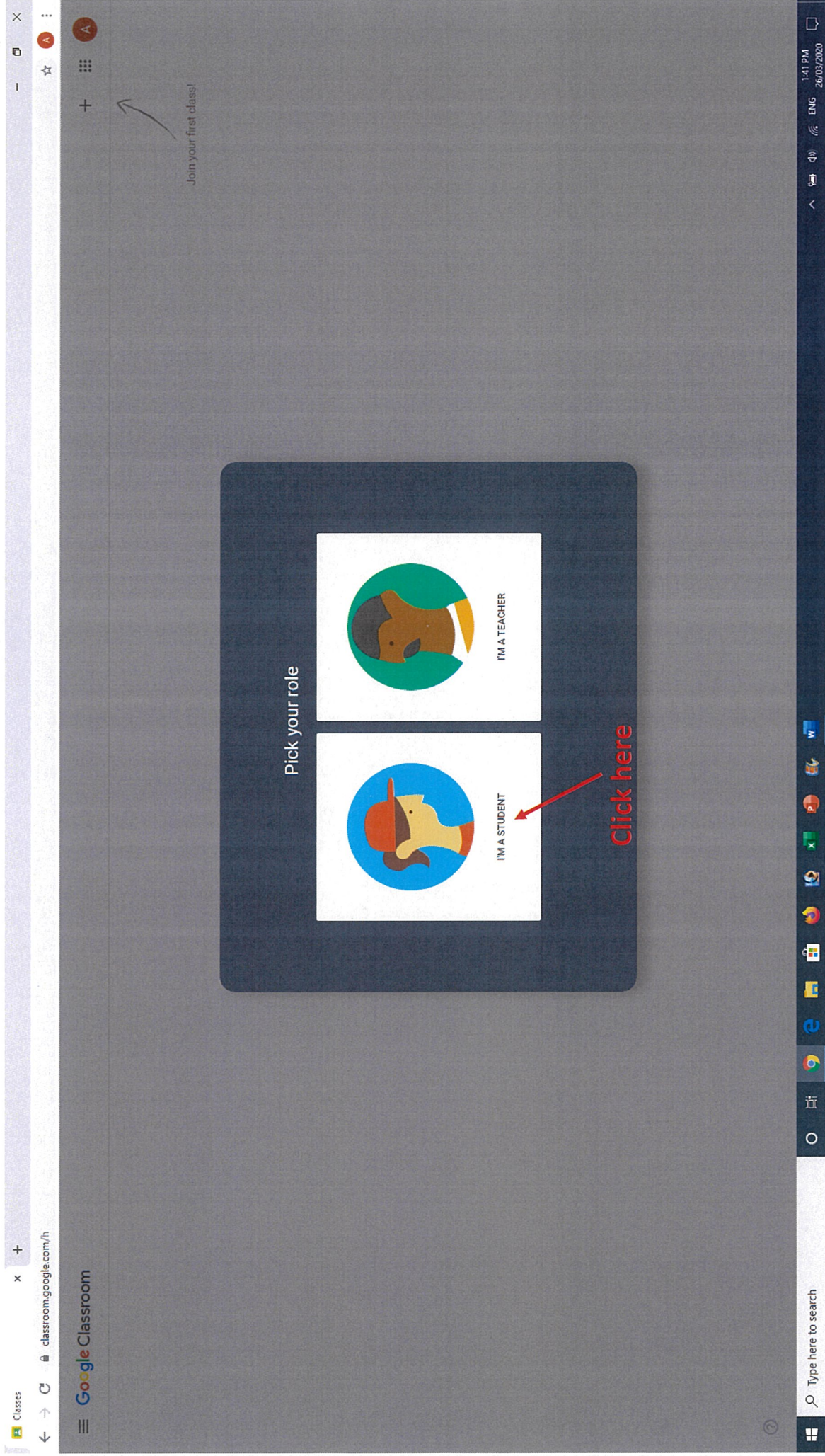

10. Click the 'I'M A STUDENT' icon.

How to access Google Classrooms instructions

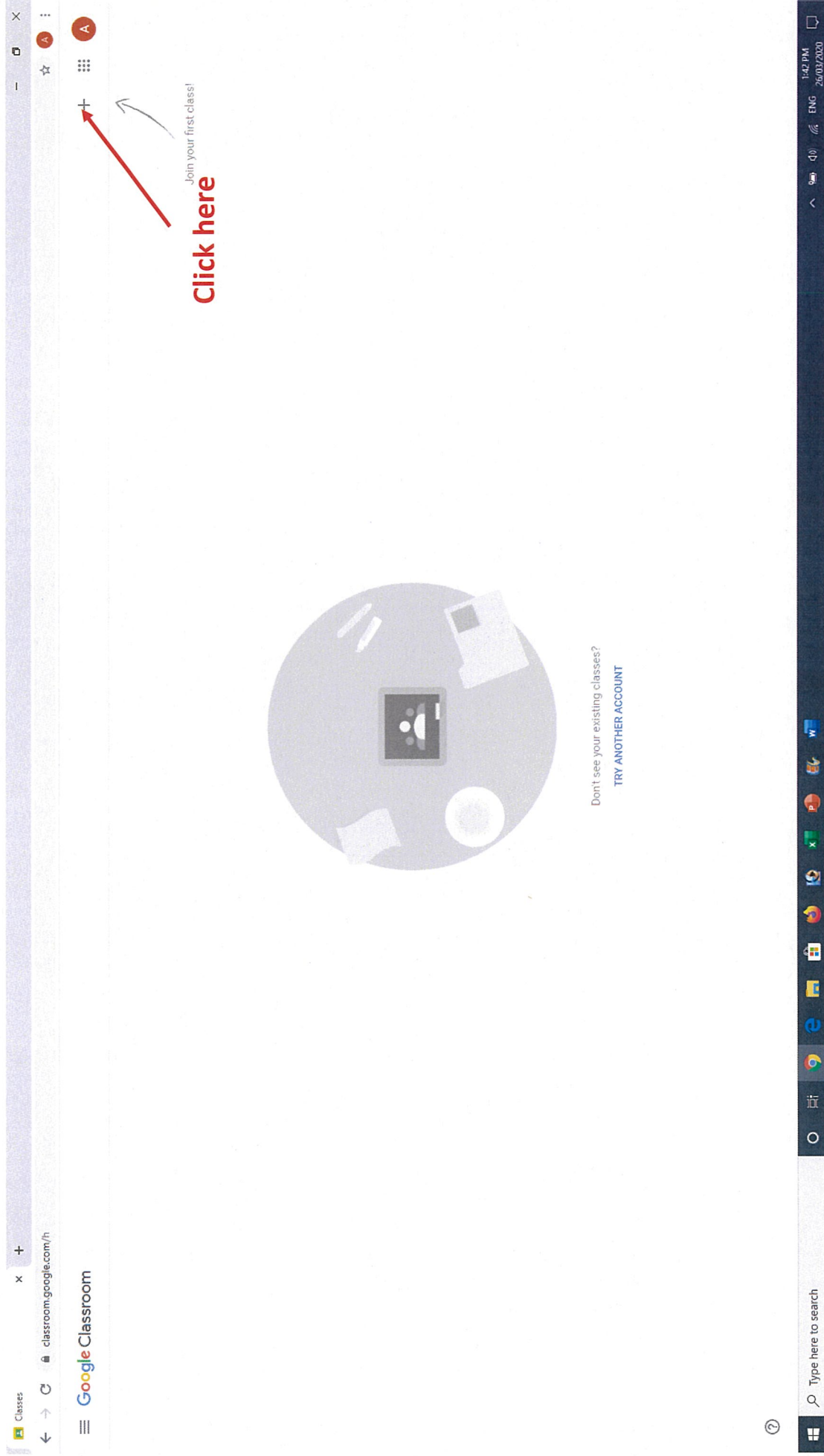

11. Click the '+' icon where it says 'Join your first class!'

How to access Google Classrooms instructions

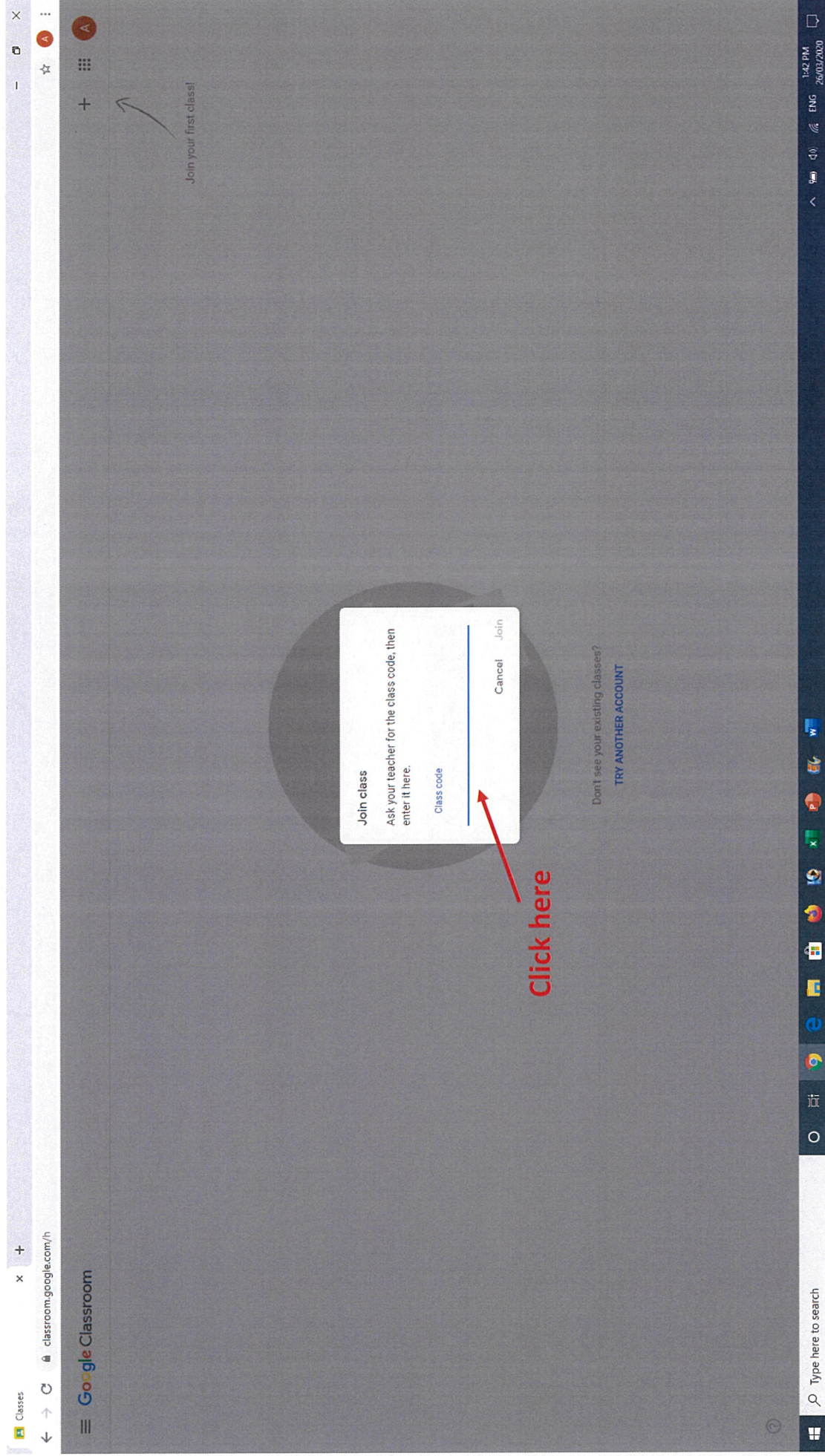

12. Type in your Class code. Click the 'Join' icon.

How to access Google Classrooms instructions

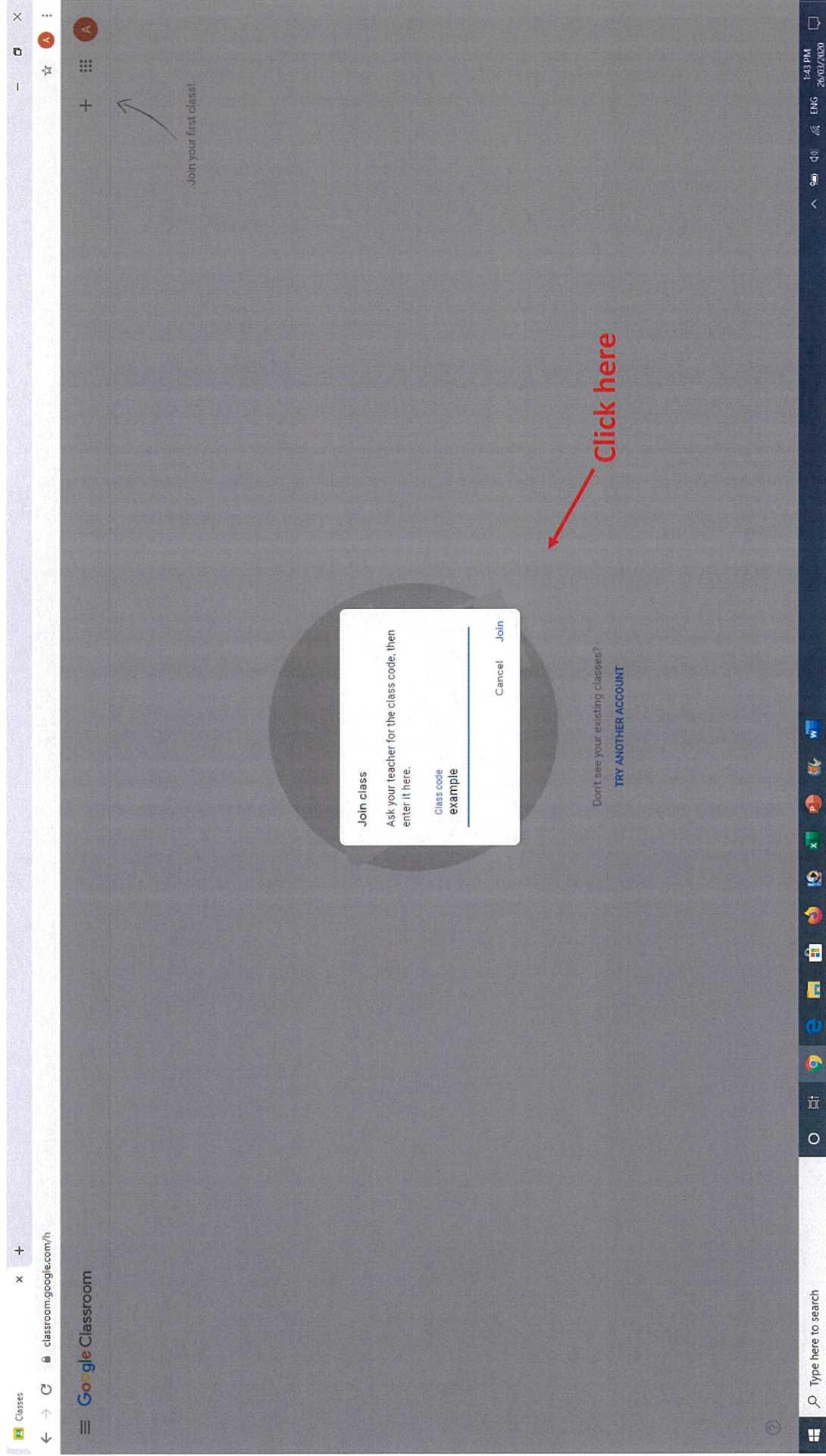

13. Click the 'Join' icon.